

## SOUHRNÝ PŘEDNÁŠEK

**Pokroky ve farmaceutické technologii***Brno, 5. září 2017*

## PŘEDNÁŠKY

**NANOTECHNOLOGY IN PERSONALISED MEDICINE AND MEDICAL DIAGNOSTICS**

JOSEF MAŠEK

Department of Pharmacology and Immunotherapy, Veterinary Research Institute, Brno, Czech Republic  
e-mail: masek@vri.cz

Personalized medicine encompasses complex approach of several scientific disciplines to tailor medical treatment to the individual characteristics of each patient. Crucial aspect of individualised therapy is in understanding of how unique molecular and genetic profiles of patients will influence parameters like susceptibility of patients to diseases, prognosis of a certain disease or prediction which medical treatments will be safe and effective for each patient. Advances in genomics, transcriptomics, proteomics, metabolomics, and bioinformatics make personalized medicine possible.

Nanotechnology plays essential role in this field. Examples of individualised approach include using nanoparticle-based targeted therapies to treat specific types of cells, nanodiagnosics and its combination – so called theranostics. The use of nano-based theranostics offers applications such as simultaneous real-time monitoring of drug delivery systems and disease progress. Cancer treatment, individualised cell-based vaccination strategy or gene therapy are great examples of nanotechnology-based personalised medicine and diagnostics.

Advances in the research, healthcare, policy and future definition of ethical rules enabling individualised medicine have high potential to improve the quality of patient care.

*This work was supported by the project „FIT“ (Pharmacology, Immunotherapy, nanoToxicology) CZ.02.1.01/0.0/0.0/15\_003/0000495 funded by the European Regional Development Fund.*

**INDIVIDUALIZATION OF THERAPY USING PHARMACEUTICAL TECHNOLOGY**

JAN GAJZDIOK, JANA MALÁ

Department of Pharmaceutics, Faculty of Pharmacy, University of Veterinary and Pharmaceutical Sciences, Brno, Czech Republic  
e-mail: gajzdiokj@vfu.cz

Currently, there is a growing awareness of constraints associated with mass-produced medicines. At the same time, new technologies for the manufacture of drugs are being developed, with which some drugs could be successfully moved to the field of individualized therapy belonging to personalized medicine approach.

These technologies include various printing methods such as inkjet, flexographic and additive manufacturing technology (3D printing). Flexibility of doses can be also ensured, for example, by a dosing pen for solid dosage microforms. Other possibilities represent using of multiple dosage forms, such as pellets and minitables, and associated dosing devices for them<sup>1</sup>.

The concept of individualized therapy means the choice of treatment that best fits the individual patient requirements. It is also referred to as personalized medicine and is mainly associated with genomics. However, this view on personalized medicine is often criticized for being limited to a too limited area. It does namely not include aspects such as the kind of administration of the active substance - individualized therapy from the point of view of pharmaceutical technology<sup>2</sup>. Clearly, suitable dosage and application forms for selecting and administering individualized doses are essential to transfer knowledge of personalized medicine to everyday clinical practice. Individualized drug therapy improves patient compliance and adherence to the treatment and contributes to addressing some issues associated with efficacy and the overall success of the treatment approach<sup>3</sup>.

The primary reason for the individualization of therapy represent inter- and intraindividual differences between patients. There must be also mentioned the historical background of individualized therapy, which was preferred in the past, and the gradual transition from individually prepared medicinal products to today's systems of mass-produced dosage forms. Individualized therapy is a current research hot topic, which brings a number of innovative suggestions. Increasing knowledge into this area has demonstrated the need for individual dosing and developing of dosage forms and drug delivery devices/ systems tailored to the individual patient.

**References**

1. **Alomari M., Mohamed F.H., Basit A.W., Gaisford S.** Personalised dosing: Printing a dose of one's own medicine. *Int. J. Pharm.* 2014; 494, 568–577.
2. **Jain K. K.** Textbook of Personalized Medicine. 1. vydání. Springer 2014.
3. **Breitkreutz J., Boos, J.** Paediatric and geriatric drug delivery. *Exp. Opin. Drug Deliv.* 2007; 1, 37–45.

## EFFECT OF WARFARIN TABLETS ON POTENTIAL BLEEDING DURING GENERIC SWITCHING

ALEŠ FRANČ<sup>1</sup>, JAN MUŠELÍK<sup>1</sup>, ROMAN GONĚC<sup>2</sup>

<sup>1</sup>Department of Pharmaceutics, Faculty of Pharmacy, University of Veterinary and Pharmaceutical Sciences Brno, Czech Republic

<sup>2</sup>Hospital pharmacy, Masaryk Memorial Cancer Institute, Brno, Czech Republic

e-mail: franca@vfu.cz

Warfarin is an anticoagulant with a narrow therapeutic index (NTI). In the past, monitored cases of bleeding attributable to fluctuations in drug content uniformity or switching from crystalline to amorphous substance were observed<sup>1</sup>. Definitive conclusions have not been published, but there are limitations of generic switching in some countries<sup>2</sup>. By reviewing references, this lecture will try to clarify if the bleeding was caused by the switch from crystalline form to amorphous form or by failed content uniformity of tablets. From the viewpoint of state of the art technology and clinical data it can be concluded that crystalline form of the active substance does not play major role in generic switch. There are examples of bioequivalent drugs that differ in the form of active substance. For instance, in the Czech Republic there is Warfarin Orion containing amorphous substance and Warfarin PMCS containing crystalline substance; elsewhere, there is Coumadine by DuPont which contains crystalline substance and Warfarin Pliva which contains amorphous substance and that are bioequivalent<sup>3</sup>. This conformance is probably caused by the fact that warfarin sodium is changed in gastric acidic environment into warfarin base ( $pK_A = 5$ ) which precipitates because of its insolubility; subsequently, in neutral environment of the intestine, warfarin base is dissolved. No matter if crystalline or amorphous at the beginning, the absorption is delayed and performed under different circumstances. When evaluating dissolution profiles in water or in simulated intestinal fluid, using paddles at reduced speed (25 rpm), there is significant difference between Warfarin Orion and PMCS. Dissolution method required by USP monograph which uses water and paddle rotations at 50 rpm does not have this discerning ability. Another method can be used in quality control; two phase dissolution method is able to monitor the transition of sodium salt to free base in simulated gastric fluid and the transport of this base into organic octanol phase imitates lipophilic components of biological membranes that enable the absorption of the drug under physiological conditions<sup>4</sup>. When comparing tablets manufactured from amorphous and crystalline substance in laboratory conditions, it was found out that the difference in dissolution profiles can not be induced by different form of active substance (amorphous vs crystalline), however, it can be caused by different manufacturing technology (direct compression vs granulation). The fact that generic switch was not responsible for cases of bleeding was also confirmed by metaanalyses of clinical studies that compared therapy by Coumadine and generic products<sup>1</sup>. It is probably content uniformity that is responsible for possible complications,

respectively bleeding. Therefore, content uniformity has to be maintained so as to assure reproducible dosing with respect to titrated blood level<sup>5</sup>. To achieve good content uniformity, granulation, impregnation, or direct compression can be used, however, these processes have to be optimized. For optimization, statistical methods are suitable, including process capability index and Bergum division. Multidimensional data analysis can be used to evaluate the results<sup>6</sup>. In conclusion, the form of the active substance does not play a role in generic switch. However, content uniformity has to be met not only pharmacopoeial limits, but also stricter statistical limits based on confidence levels.

## References

1. Haines S. T. Substituting warfarin products: what's the source of the problem? *Ann. Pharmacoter.* 2011; 45, 807–809.
2. Hellfritzsche M., Rathe J., Stage T. B., Thirstrup S., Grove E. L., Damkier P., Pottegård A. Generic switching of warfarin and risk of excessive anticoagulation: a Danish nationwide cohort study. *Pharmacoepidemiol. Drug. Saf.* 2016; 25, 336–343.
3. Franc A., Rabišková M., Goncec R. Impregnation: a progressive method in the production of solid dosage forms with low content of poorly soluble drugs. *Eur. J. Pharm. Sci.* 2011; 16, 85.
4. Franc A., Muselík J., Goněc R., Vetchý D. Biphasic dissolution method for quality control and assurance of drugs containing active substances in the form of weak acid salts. *Acta Pharm.* 2016; 66, 139–145.
5. Muselík J., Franc A. Evaluation of content uniformity of tablets with a low content of the active ingredient with a narrow therapeutic index. *Ces. slov. Farm.* 2012; 61, 271–275.
6. Muselík J., Franc A., Doležel P., Goněc R., Krondlová A., Lukášová I. Influence of process parameters on content uniformity of a low dose active pharmaceutical ingredient in a tablet formulation according to GMP. *Acta Pharm.* 2016; 64, 355–367.

## INFLUENCE OF SUB-ANAESTHETIC DOSE OF KETAMINE ON ADDICTIVE BEHAVIOURS IN RATS

JANA RUDA-KUCEROVA<sup>1</sup>, ZUZANA BABINSKA<sup>1</sup>, MATEJ L'UPTÁK<sup>1</sup>, TIBOR STARK<sup>1</sup>, VINCENZO MICALE<sup>2,3</sup>

<sup>1</sup>Department of Pharmacology, Faculty of Medicine, Masaryk University, Brno, Czech Republic

<sup>2</sup>CEITEC – Central European Institute of Technology, Masaryk University, Brno, Czech Republic

<sup>3</sup>Department of Biomedical and Biotechnological Sciences, Section of Pharmacology, School of Medicine, University of Catania, Catania, Italy

e-mail: jkucer@med.muni.cz

**Introduction:** Drug addiction is a serious psychosocial problem. Most of the treatment options including pharmacologic and psychologic focus on support of sustained drug abstinence. Recently anti-glutamatergic mechanisms were proposed as a promising treatment of drug addiction. Several *N*-methyl-D-aspartate (NMDA) receptor antagonists such as dizocilpine, ketamine but also acamprosate and memantine were shown to exert clinical anti-craving effects. Similarly, other pharmacologic mechanism leading to inhibition of glutamatergic signalling also seem to possess this

potential<sup>1</sup>). Ketamine at sub-anaesthetic doses is now extensively studied for its acute antidepressant potential in both animal and clinical studies and preclinical experiments with promising results. In regard of addictive disorders, ketamine was shown to dose-dependently reduce cocaine craving 24 hours post infusion<sup>2</sup>. Thus, we investigated the effects of sub-anesthetic doses of ketamine on methamphetamine operant self-administration and alcohol intake in a voluntary alcohol drinking paradigm.

### Experimental methods:

#### Animals

Adult male albino Wistar and Sprague-Dawley rats were housed individually in standard rodent plastic cages. Environmental conditions during the whole study were constant: relative humidity 50–60 %, room temperature 23 °C ± 1 °C, inverted 12-hour light-dark cycle (6 a.m. to 6 p.m. darkness). All procedures were performed in accordance with EU Directive no. 2010/63/EU and approved by authorities in compliance with Czech Animal Protection Act No. 246/1992.

#### Drugs and treatments

Methamphetamine (METH, Sigma Chemical, Co., St Louis, MO, USA) dose was 0.08 mg/kg per infusion with the maximum number of infusions obtainable in one session set to 50.

Ethanol was purchased from a local pharmacy and dissolved by distilled water to desired concentration (10 to 20%).

Ketamine solution was prepared by diluting a ready-made solution (NARKAMON inj. ad us. vet., Bioveta Inc., Czech Republic) by saline to obtain a concentration of 5 or 10 mg/kg ketamine in 1 ml of solution.

#### Methamphetamine IV self-administration protocol

Animals were anesthetized and an intracardiac silastic catheter was implanted through the external jugular vein to the right atrium. After surgery, a one week recovery was allowed. The catheters were flushed daily by 17 mg/kg enrofloxacin solution followed by 0.1 ml of a heparinized (1%) saline solution. IVSA was conducted in operant boxes (Coulbourn Instruments, USA). After 14 days of METH intake the rats were kept in their home cages for another 14 days of the forced abstinence period<sup>3</sup>. Then animals were introduced again to the IVSA boxes to re-establish drug-taking behaviour for 5 days. When self-administration behaviour was stable for 3 days, an intraperitoneal injection of saline was administered to assess the effect of injection on the METH intake. After reaching the stable intake again a 5 mg/kg ketamine dose was administered intraperitoneally 20 minutes before the session.

#### Alcohol drinking paradigm

The drinking in dark paradigm was used with sucrose fading procedure: The procedure started at 10% /5% (alcohol/sucrose) (3 days), 15%/5% (3 days), 20%/5% (4 days), 20%/2% (3 days), 20%/1% (4 days). The daily drinking session lasted 90 minutes. From day 18 onward, for 23 days the animals were given 20% alcohol only<sup>4</sup>. On the test day (day 41), rats were randomly divided into

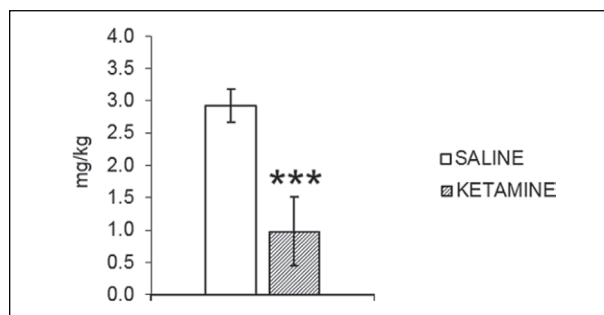

Fig. 1. Acute ketamine (5 mg/kg) pretreatment suppresses METH self-administration

treatment groups and a dose of 5 or 10 mg/kg ketamine or saline was injected intraperitoneally 20 min before the alcohol drinking session. Alcohol intake was calculated as grams of ethanol per kg of body weight.

### Results and discussion:

#### Ketamine effect on methamphetamine IV self-administration

After reaching a stable self-administration behaviour for 3 days, an IP injection of saline was administered to assess the effect of injection on the METH intake. After reaching the stable intake again an IP ketamine dose was administered before the session. The results are depicted on the Figure 1 in terms of METH dose self-administered in mg/kg. Ketamine treatments suppressed METH taking behaviour (t-test, \*\*\*p = 0.0008).

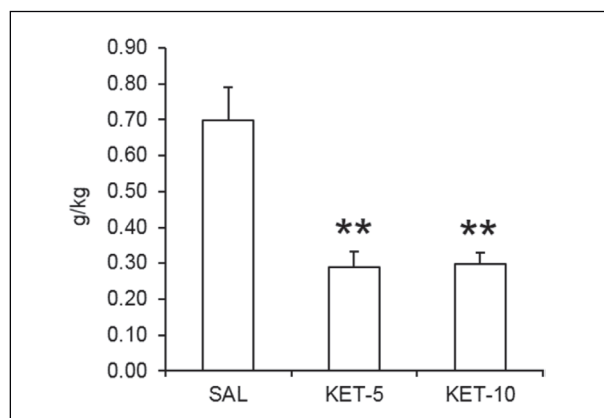

Fig. 2. Acute ketamine (5 and 10 mg/kg) pretreatment suppresses METH self-administration

#### Ketamine effect on alcohol drinking

The effect of ketamine pre-treatment on alcohol intake is shown in Figure 2. The results are presented as amount of alcohol consumed (g/kg bw) on the test day. 1W ANOVA revealed a significant effect of treatment on alcohol intake (g/kg bw):  $F(5,30) = 4.13$ ,  $p = 0.006$ . Dunnett post-hoc test showed a significant effect of ketamine at 5 mg/kg dose (KET-5,  $p = 0.008$ ); 10 mg dose (KET-10,  $p = 0.008$ ).

**Conclusions:** Our study indicates that ketamine blocks operant METH intake and alcohol drinking. This effect may be mediated by AMPA or kainate-receptor transmission. Furthermore, d-amphetamine discontinuation in rats was shown to suppress BDNF

release in several brain regions and this effect was restored by 10 mg/kg dose of ketamine<sup>5</sup>). Therefore, ketamine-induced enhancement of BDNF may also contribute to the explanation of its beneficial effect in METH withdrawal phase. These mechanisms may explain the clinically proven anti-craving potential of ketamine and further research could allow development of more specific anti-craving medications with less risks.

*This study was performed at Masaryk University as part of the Specific University Research Grant „Experimental and translational pharmacological research and development” number MUNI/A/1063/2016 with the support of the Specific University Research Grant, as provided by the Ministry of Education, Youth and Sports of the Czech Republic in the year 2017.*

## References

1. Holmes A., Spanagel R., Krystal J. H. Glutamatergic targets for new alcohol medications. *Psychopharmacology* 2013; 229, 539–554.
2. Dakwar E., Levin F., Foltin R. W., Nunes E. V., Hart C. L. The effects of subanesthetic ketamine infusions on motivation to quit and cue-induced craving in cocaine-dependent research volunteers. *Biol Psychiatry* 2014; 76, 40–46.
3. Ruda-Kucerova J., Amchova P., Babinska Z., Dusek L., Micale V., Sulcova A. Sex differences in the reinstatement of methamphetamine seeking after forced abstinence in Sprague-Dawley rats. *Front Psychiatry* 2015; 6(91), 1–8.
4. Ruda-Kucerova J., Babinska Z., Amchova P., Stark T., Drago F., Sulcova A., Micale V. Reactivity to addictive drugs in the methylazoxymethanol (MAM) model of schizophrenia in male and female rats. *World J Biol Psychiatry* 2016; 18(2), 129–142.
5. Fuller J. J., Murray R. C., Horner K. A. D-Amphetamine withdrawal-induced decreases in brain-derived neurotrophic factor in sprague-dawley rats are reversed by treatment with ketamine. *Neuropharmacology* 2016; 97, 7–17.

## A DYNAMIC ANGLE OF REPOSE STUDY USING PHARMACEUTICAL EXCIPIENTS

HANA HURYCHOVÁ<sup>1</sup>, MARTIN KUENTZ<sup>2</sup>, ZDENKA ŠKLUBALOVÁ<sup>1</sup>

<sup>1</sup>Charles University, Faculty of Pharmacy, Department of Pharmaceutical Technology, Hradec Králové, Czech Republic

<sup>2</sup>University of Applied Sciences and Arts Northwestern Switzerland, School of Life Sciences, Institute of Pharma Technology, Muttenz, Switzerland

e-mail: hurychh@faf.cuni.cz

In pharmaceutical technology, the determination of the Hausner ratio, the static angle of repose or the flow rate through an orifice are standard methods generally used to test flowability of powder materials. However, powder samples can be challenging to measure in case of increased cohesivity, which may be caused by a small particle fraction and that typically leads to poor flow properties. A more recent method to cope with samples of poor flow properties is dynamic image analysis of powder avalanching.

Avalanche testers use a special rotary drum designed to study the dynamic flow properties of powder materials. The Aeroflow<sup>®</sup>, Granudrum<sup>™</sup>, and Revolution<sup>®</sup> powder analyzer represent commercial testers. The latter two methods facilitate dynamic image analysis.

During the measurement, a rotary drum with a powder sample is turning around a central axis and a digital camera with the assistance of backlight illumination takes digital images of the powder flow (Fig. 1). While collecting the images, the software calculates various dynamic parameters such as the avalanche angle, the avalanche time, and the avalanche energy. Moreover, dynamic image analysis of the powder bulk provides a fractal contour line dimension of the surface.

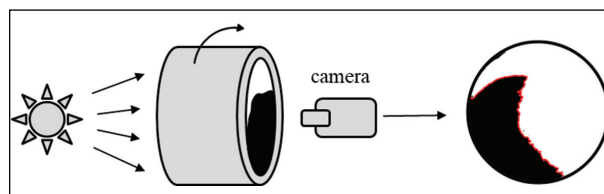

Fig. 1. The principle of measurement

In Fig. 2, the different avalanche regimes of powder flow are illustrated<sup>1</sup>. The most common regimes include a slumping, cascading and cataracting behaviour. The rotary drum allows to measure avalanche characteristics of powders, mixtures or granular materials. It is practically used to observe the behaviour under different processing simulations, e.g. the blending<sup>2</sup>, capsule-filling<sup>3</sup>, tableting or transportation.

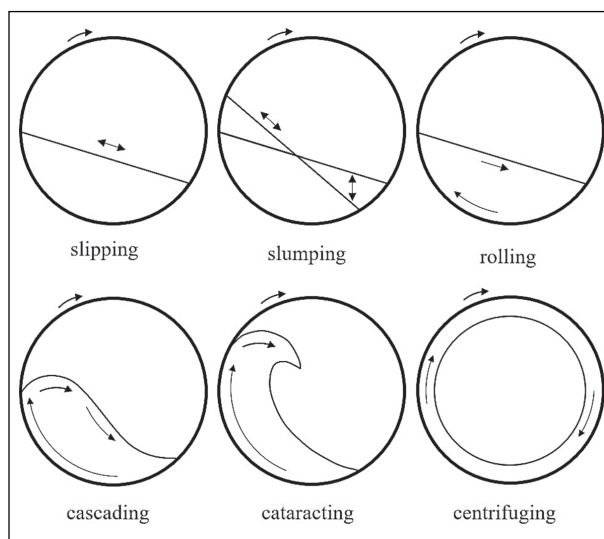

Fig. 2. Illustration of the avalanche regimes

Results of different pharmaceutical samples are presented and discussed. Avalanche testing of powders is a useful and promising supplement of the standard Pharmacopoeial methods for pharmaceutical powders, especially for highly cohesive samples, which are difficult to measure by common methods.

*This work was supported by the Funding Agency of Charles University under Grant No. 322315/2015 and the Funding Agency of Charles University under Grant No. SVV 260 401.*

## References

1. Henein H., Brimacombe J. K., Watkinson A. P. The modelling of transverse solids motion in rotar kilns. *Metall. Trans. B.* 1983; 14B, 207–220.
2. Nalluri V. R., Kuentz M. Flowability characterisation of drug–excipients blends using a novel powder avalanching method. *Eur. J. Pharm. Biopharm.* 2010; 14, 388–396.
3. Nalluri V. R., Puchkov M., Kuentz M. Toward better understanding of powder avalanching and shear cell parameters of drug–excipient blends to design minimal weight variability into pharmaceutical capsules. *Int. J. Pharm.* 2013; 442, 49–56.

## POSTERY

### SELF-EMULSIFYING DRUG DELIVERY SYSTEMS CONTAINING CELLACEFATE FOR INTRA-ORAL LIPOPHILIC DRUGS ADMINISTRATION

VERONIKA PECHOVÁ<sup>1</sup>, JAN GAJZIOK<sup>1</sup>, NOEMI LUPO<sup>2</sup>, ANDREAS BERNKOP-SCHNÜRCH<sup>2</sup>

<sup>1</sup>Department of Pharmaceutics, Faculty of Pharmacy, University of Veterinary and Pharmaceutical Sciences, Brno, Czech Republic

<sup>2</sup>Department of Pharmaceutical Technology, Institute of Pharmacy, University of Innsbruck, Innsbruck, Austria  
e-mail: gajdziokj@vfu.cz

**Introduction:** Self-emulsifying drug delivery systems represent an isotropic mixture of oils, surfactants, co-surfactants and co-solvents that spontaneously form transparent and kinetically stable emulsions after gentle agitation<sup>1</sup>. Self-nanoemulsifying drug delivery systems (SNEDDs) are characteristic by the formation of oil in water nanoemulsion (o/w) with size of inner oil phase maximum 1 µm. The nanoemulsion is usually prepared by mixing small volume of SNEDDs in aqueous media at room temperature. Self-emulsifying drug delivery systems are used to increase bioavailability of lipophilic active substances<sup>2</sup>, more recently also for protein delivery and gene therapy<sup>1,3</sup>. The aim of the experimental work was the formulation of SNEDDs containing cellacefate (CAP, cellulose acetate phthalate). CAP was chosen due to its hydrophobic nature, potential ability to bind lipophilic active substances and the possibility to prolong the residence time on oral mucous membrane. At the beginning of the experiment, compatibility of available excipients was evaluated. Subsequently, the size of inner oil phase was measured in two aqueous media varying in the pH.

## Experimental methods:

**Materials and method of SNEDDs preparation**

SNEDDs were prepared by gradual addition of all excipients to dissolved 10 mg of CAP (Sigma Aldrich, USA) in transcitol (Sigma Aldrich, USA), tetraglycol (Sigma Aldrich, USA) or in a mixture of transcitol with propylenglycol (PG, Gatt-Koller, Austria). The order of excipient addition was: surfactant (Tween 80, Sigma Aldrich, USA), co-surfactant (labrasol, Gattefossé, France) and oil (triethylcitrate, Alta Aesar, USA). Even though triethylcitrate possesses hydrophilic character, it is regularly used in SNEDDs formulations as lipophilic phase<sup>4</sup>. After each excipient addition, homogenization was performed using vortex mixer SA 8 (Stuart, Great Britain). Composition of the prepared SNEDDs is summarized in Table 1. At the same time, blank samples without CAP were formulated. Blank samples contained solvent, co-solvent, surfactant and oil in the same ratio as samples with CAP. The total weight of each SNEDDs sample was 1 g.

**Evaluation of nanoemulsions**

Nanoemulsions were prepared in diluted HCl pH 1.9 and in simulated saliva buffer pH 6.75. After addition of defined quantity of SNEDDs to media, nanoemulsion was spontaneously formed after gentle agitation. Concentration of each nanoemulsion in media was 1%. In the obtained nanoemulsions, the size of inner phase was determined using Zetasizer Nano ZSP (Malvern, Great Britain).

**Results and discussion:** In Table 1 is summarized composition of the evaluated compatible SNEDDs containing 10 mg of CAP. The appearance of compatible SNEDDs is transparent, without any opalescence. In the framework of presented compatibility study, four other solvents and their mixtures, another hydrophilic surfactant Kolliphor EL (Sigma Aldrich, USA), eight other co-surfactants and even thirteen other oils were evaluated. Unfortunately, all other compositions failed and are not listed here, because all their mixtures were turbid.

Samples A<sub>BLANK</sub>-D<sub>BLANK</sub> were prepared to determine the effect of CAP on the size of inner phase. Table 2 presents an overview of inner nanoemulsion size without CAP. More values of results indicate that the size of the inner phase was not uniform and the size distribution was recorded. Values exceeding the limit of 1 µm (e.g. 4745.0 nm; 5304.0 nm) represent the possible presence of dust particles in the sample and can therefore be neglected.

Table 1. Composition of SNEDDs

Sample	Solvent		Cosolvent		Surfactant		Cosurfactant		Lipophilic phase	
	type	mg	type	mg	type	mg	type	mg	type	mg
A	transcitol	200	–	–	Tween 80	350	labrasol	200	triethylcitrate	250
B	transcitol	200	–	–	Tween 80	350	labrasol	100	triethylcitrate	350
C	transcitol	100	PG	100	Tween 80	350	labrasol	200	triethylcitrate	250
D	tetraglycol	200	–	–	Tween 80	350	labrasol	200	triethylcitrate	250

Table 2. Size of inner phase without CAP

Sample	HCl pH 1.9		Simulated saliva buffer pH 6.75	
	Size (nm)	Intensity (%)	Size (nm)	Intensity (%)
A <sub>BLANK</sub>	11.6	100.0	12.1	68.0
			374.0	26.4
			4745.0	5.6
B <sub>BLANK</sub>	251.9 10.2 75.3	68.0 16.8 15.2	334.2	79.9
			10.1	18.5
			5304.0	1.6
C <sub>BLANK</sub>	240.2 10.7 4691.0	55.2 41.8 3.0	11.1	63.0
			266.5	37.0
D <sub>BLANK</sub>	10.9 465.6	80.0 20.0	13.3	67.4
			611.9	29.6
			4517.0	3.0

Table 3. Size of inner phase with CAP

Sample	HCl pH 1.9		Simulated saliva buffer pH 6.75	
	Size (nm)	Intensity (%)	Size (nm)	Intensity (%)
A	163.1	100.0	11.7	73.2
			317.0	26.8
B	445.4 101.9 9.6	44.6 33.6 21.8	206.8	69.8
			12.2	19.4
			3409.0	10.8
C	135.4	100.0	11.5	96.5
			4909.0	3.5
D	132.6	100.0	11.6	90.7
			339.4	7.2
			523.0	2.1

The other measured values of the size of the inner phase without CAP do not exceed the 1  $\mu\text{m}$  limit and meet the standards for nanoemulsion.

Table 3 shows results obtained by measuring the inner phase of nanoemulsion with CAP (samples A-D). In two cases the presence of dust particles can be noted again. Also in samples with CAP the size distribution was recorded and the size of the inner phase with CAP meets the limit in all cases as well. Comparing the size of the inner phase with and without CAP it can be concluded that in an acidic pH the size of the inner phase of nanoemulsions with CAP is greater and in a pH 6.75 the size of the internal phase does not change significantly.

**Conclusions:** To meet the aim of the experimental work, four different SNEDDs compatible with CAP polymer were prepared. The size of the inner phase of the resulting nanoemulsions in aqueous media did not exceed 1  $\mu\text{m}$  limit, taking into account the possibility of presence some dust particles in the tested samples.

The work was supported by the Erasmus+ program.

## References

- Zupančič O., Partenhauser A., Lam H. T., Rohrer J., Bernkop-Schnürch A. Development and in vitro characterisation of an oral self-emulsifying delivery system for daptomycin. *Eur. J. Pharm. Sci.* 2016; 81, 129–136.

- Seilerová L., Sieberová V., Kratochvíl B., Vetchý D. Využití samoemulgujících systémů pro zlepšení rozpustnosti a biodostupnosti léčiv. *Chem. Listy* 2014; 108, 956–960.
- Hauptstein S., Prüfert F., Bernkop-Schnürch A. Self-nanoemulsifying drug delivery systems as novel approach for pDNA drug delivery. *Int. J. Pharm.* 2015; 487, 25–31.
- Köllner S., Nardin I., Markt R., Griesser J., Prüfert F., Bernkop-Schnürch A. Self-emulsifying drug delivery systems: Design of a novel vaginal delivery system for curcumin. *Eur. J. Pharm. Biopharm.* 2017; 115, 268–275.

## GOLDCELL® SELENIUM YEAST: FLOW CHARACTERIZATION, HOPPER GEOMETRY DESIGN AND ARCHING HEIGHT DETERMINATION

LUCIE JEZERSKÁ<sup>1</sup>, JAKUB HLOSTA<sup>1</sup>, KATEŘINA BÍLKOVÁ<sup>2</sup>, JIŘÍ ZEGZULKA<sup>1</sup>, JAN NEČAS<sup>1</sup>

<sup>1</sup>VSB-Technical University of Ostrava, ENET Centre, Bulk Solids Centre, Ostrava, Czech Republic

<sup>2</sup>AQM Ltd., Bohumin, Czech Republic  
e-mail: lucie.jezerska@vsb.cz

**Introduction:** Natural GoldCell® yeasts contain a significant amount of organic selenium, a trace element essential to the human metabolism<sup>1</sup>). Selenium is a rare mineral in nature, therefore, it is also only found in small amounts in the diet. An example may be the content of selenium in meat, fish and eggs in the range of 0.01 to

1.5 µg/g, in dairy products 0.001–0.30 µg/g, in fruit 0.001–0.022 µg/g<sup>2</sup>). It has significant effects on the human organism. Selenium plays an important role in a number of basic physiological functions, including conversion of the thyroid hormone, prevention of cardiovascular disease and reduction of the risk of developing various types of cancer<sup>3</sup>). It works as an antioxidant, it is essential for the normal functioning of the immune system and the thyroid gland, and improves the quality of hair and nails<sup>4,5</sup>). In food supplements it is possible to use either its organic or inorganic form. However, the organic version of selenium is more usable for the organism (bioavailability). In the study, a basic characterization of the flow of the organic powder form of selenium – selenium yeast GoldCell<sup>®</sup> was performed. The high degree of cohesiveness of the powdered form of selenium yeast, evaluated by several different flow parameters, led to the necessity of a precise design of a suitable hopper (feeder) geometry based on the determination of the internal friction angles at three sizes of consolidation stress, wall friction on stainless steel and compressibility. The locations of the formation of static and dynamic arches were determined.

**Experimental methods:**

**Material**

GoldCell<sup>®</sup> My Se20 – inactive dry yeast.

**Determination of dynamic behaviour and flowability**

The dynamic behaviour of GoldCell<sup>®</sup> selenium yeasts was observed using a method of a rotating roller of 140 mm diameter and 30 mm thick (Fig. 1). Filling was 50%. The rotation frequency ranged from 20 to 60 rpm. Flowability was determined on the basis of the static pour angle analysis by pouring the powder from the hopper onto the mat. Further, the Hausner ratio and the Carrs index,

calculated from the bulk density<sup>6</sup>) were evaluated. The flow function, ffc, was calculated as a ratio of major principal stress ( $\sigma_1$ ) and unconfined yield strength ( $\sigma_c$ ) evaluated during the measurement of the internal friction angle.

**Design of the hopper geometry – measuring the angle of internal friction, compressibility and wall friction**

The device used for measuring bulk properties necessary for the hopper design was the FT4 Powder Rheometer.

**Angle of internal friction**

The rotary shear module for measuring friction parameters consists of a vessel containing the sample powder and a shear head to cause normal and shear stress. The blades of the shear head sink into the mass powder and the front face of the head starts to apply normal stress to the surface of the powder bed. The shear head moves downwards until a sufficient and stable pressure is applied between the head and powder bed. Then the shear head starts to rotate slowly and thus cause shear stress within the bulk mass. The shear plane is formed just below the end of the blades. Since the powder bed prevents the rotation of the shear head, the shear stress in the measuring plane increases until slippage occurs. Then, the maximum value of transferred shear stress is recorded. The angle of internal friction was determined at three degrees of consolidation stress – 3, 6 a 9 kPa.

**Compressibility**

Compressibility was measured as the change in volume or density, respectively, depending on a normal load. The data obtained are quantified by expressing the percentage of compressibility for a normal load of 15 kPa.

**Wall friction angle**

The wall friction angle is the angle at which bulk material begins to slide over the bed. The wall friction coefficient varies with the size of normal pressure. The measurement is based on the same principle as measuring the angle

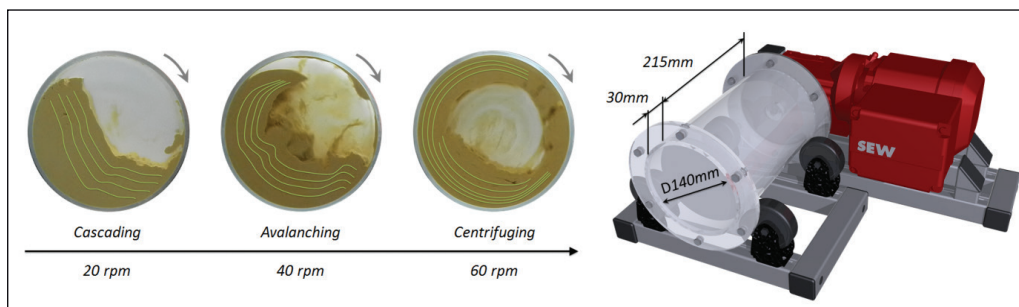

Fig. 1. Left – dynamic behaviour of GoldCell<sup>®</sup> selenium yeast in the rotating drum with increasing rotation frequency, right – the rotating drum

Table 1. Evaluation of GoldCell<sup>®</sup> selenium yeast flowability

Parameter	Value	Flowability
HR (-)	1.31	average
CI (%)	23.5	average
AoR (°)	49.6	poor
ffc (-)	2.02	cohesive

HR – Hausner ratio, CI – compressibility index, AoR – angle of repose, ffc – flow function

of internal friction. Only the shear head does not have shear blades, but a circular plate representing the contact material.

**Results and discussion:**

**Dynamic behaviour and flowability**

The results of the observation of the behaviour of GoldCell® selenium yeast in the rotating drum showed a marked change in the way of movement with increasing rotation frequency of the drum (Fig. 1).

Figure 1 illustrates the transition from cascade to centrifugal movement of selenium yeast. Cascading and avalanching modes are non-slip types of motion suitable for the mixing process. An extreme is the movement shown at a frequency of 60 rpm, with centrifugal forces dominating over gravitational forces, with the particles remaining motionless on the wall of the rotating drum. The parameters classifying selenium yeast in the individual flow regions are shown in Table 1. It is clear from the data that GoldCell® selenium yeast does not show good flowability. In the case of the development of a solid dosage form, it will be necessary to take this aspect into account. Measuring the angle of repose alone by means of the funnel was accompanied by arching of selenium yeast.

**Design of the hopper geometry**

The correct design of the hopper, e.g. in a tablet press or storage equipment, is important in this case, in particular to eliminate flow disturbances, static zones, or segregation. State of stress in the arch is shown generally in Figure 2<sup>7)</sup>.

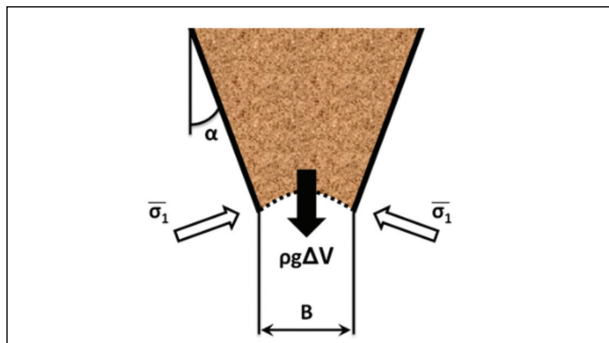

Fig. 2. State of stress in the arch – stress in the arch,  $\rho$  – density,  $g$  – acceleration due to gravity,  $\Delta V$  – volume of the arch,  $\alpha$  – hopper half angle,  $B$  – outlet size

Stress in the arch is a function of the created arc and the main normal stress  $\sigma_1$ . To ensure flow, the stress in the arch must be lower than the shear strength of the powder  $\sigma_c$ . The two hopper criteria that determine the mass flow rate required are – the outlet size ( $B$ ) and the inclination angle of the hopper ( $\alpha$ ). Data from measurements by the FT4 Powder rheometer measuring shear properties – tests for three different consolidation stress values (3, 6, 9 kPa), the values of compressibility and wall friction on stainless steel with surface roughness Ra 0.5  $\mu\text{m}$  were used for the design of the hopper geometry for GoldCell® selenium yeast. The exact design

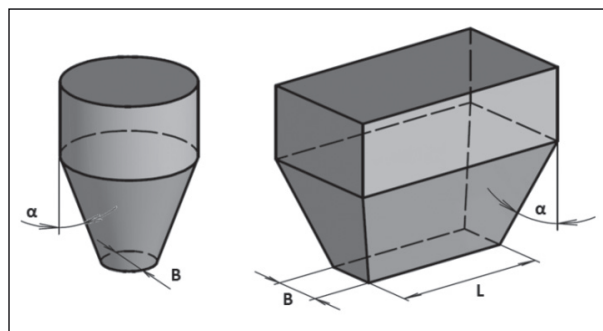

Fig. 3. Schema of the hopper geometry for axially symmetrical (left) and plane flow (right)

Table 2. Design of the hopper geometry for axially symmetrical and plane flow

Parameter	Axially symmetrical flow	Plane flow
$\alpha$ (°)	30	36
$B$ (m)	0.33	0.15
$L$ (m)	–	$\geq 0.46$

$\alpha$  – hopper half angle,  $B$  – outlet size,  $L$  – minimum length of slot for plane flow hopper

of the hopper geometry was then performed by the FT4 Powder rheometer evaluation software. The resulting values for axially symmetric and plane flow (Fig. 3) are shown in Table 2.

**Height of the arch**

The formation of the arch is influenced by a number of mechanical and physical properties of the powder, and the size and the shape of the outlet of the process equipment. The static arch is formed in the area of the piston powder flow mechanism. Dynamic arches are formed in the area of the casing flow. The height of the static and dynamic arch above the outlet, depending on the outlet size, is shown in Figure 4. The values of the effective internal

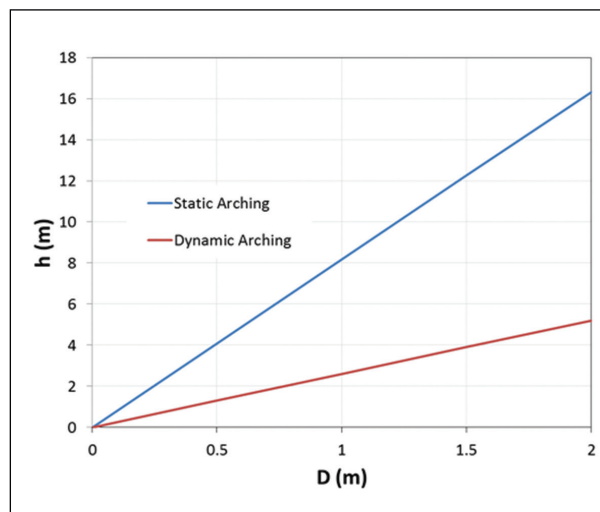

Fig. 4. Static and dynamic arch height above the outlet  $h$  – Arch height,  $D$  – outlet size



friction angle, the coefficient of bulk ability and friction were used for the calculation.

**Conclusions:** The development and production of solid dosage forms of food supplements is undergoing constant progress. To ensure trouble-free production, quality control of input materials is necessary. The aim of the article is also to highlight the parameter that is not generally evaluated – flowability. In the case of GoldCell® selenium yeast, flowability was evaluated in 4 different ways and the dynamics of the powder movement in the rotating drum was also assessed. The results show a poorly flowing powder with a tendency towards arching. The parameters of the hopper for operation without flow disturbance have been proposed and the theoretical height of the arch was determined depending on the outlet size for the potential placement of a passive element in the already existing operating system.

*This paper was conducted within the framework of the project LO1404: Sustainable development of ENET Centre and Selenium/Iodine: CZ.01.1.02/0.0/0.0/15\_019/0004711.*

## References

1. Santos M., Júnior F. M. R. S., Muccillo-Baisch A. L. Selenium content of Brazilian foods: A review of the literature values. *J. Food Compos. Anal.* 2017; 58, 10–15.
2. Dumont E., Vanhaecke F., Comelis R. Selenium speciation from food source to metabolites: a critical review. *Anal. Bioanal. Chem.* 2006; 385, 1304–1323.
3. Rayman M. P. Selenium and human health. *Lancet* 2012; 379, 1256–1268.
4. Tinggi U. Selenium: Its role as antioxidant in human health. *Environmental Health and Preventative Medicine.* 2008; 13, 102–108.
5. Ivory K., Nicoletti C. Selenium is a source of aliment and ailment: Do we need more? *Trends Food Sci. Technol.* 2017; 62, 190–193.
6. Emery E., Oliver J., Pugsley T., Sharma J., Zhou J. Flowability of moist pharmaceutical powders. *Powder Technol.* 2009; 189, 409–415.
7. Freeman T. Shear Testing. [http://www.freemantech.co.uk/\\_powders/powder-testing-shear-cells](http://www.freemantech.co.uk/_powders/powder-testing-shear-cells) (30. 6. 2017).